

= void 71

The VOID 71 is a levitation device which consists out of 2 parts; a base module and a carrier. The base module is the octagonal non-floating part which contains the technology. It has an optical sensor and needs electric power. The floating part is a magnet disc, which is called the carrier. The carrier serves as a floating plateau on which you can put an object. It can also be integrated into the presentation object.

The VOID 71 has a maximum levitation height of 70 mm and is capable of carrying loads up to 4 kg.

Specs

Carrier (floating disc):
 Height: 19 mm (0.7")
 Diameter: 180 mm (7")
 Weight: 1200 grams (2.6 Lb)

Module (base):
 Height: 28 mm (1")
 Width/Length: 284 mm (11")
 Weight: 3900 grams (8,6 Lb)

VOID 71 MAIN FEATURES

- High levitation height
- Excellent stability
- Easy to operate
- Robust optical sensing system
- Power efficient
- Ability to carry large loads

The VOID 71 is activated by inserting the powerplug into the mains. Hold the carrier, with its rubber side down, on the top of your fingertips. Hold it over the base and center it straight above the sensor until "lock" occurs and release the carrier. The presentation object can be placed on top of the carrier. Keep the center of gravity in the middle and as low as possible to acquire an optimal levitation set-up.

ELECTRICAL REQUIREMENTS & SAFETY

Connection: Two-pin EU standard electrical plug
 (US powerplug optional)
 Voltage input (AC): 100-240V
 Voltage output: 24V
 Current: 6A peak
 Power consumption (rest position): ≈10 W

Both carrier and base contain powerful magnets, therefore Crealev advises to keep magnetic sensitive devices such as credit cards at a minimum distance of 50 mm (2") from the device.

Load - Levitation Height

0 grams (0 Lb)	71 mm (2.79")
2000 grams (4.4 Lb)	43 mm (1.69")
4000 grams (8.8 Lb)	31 mm (1.22")

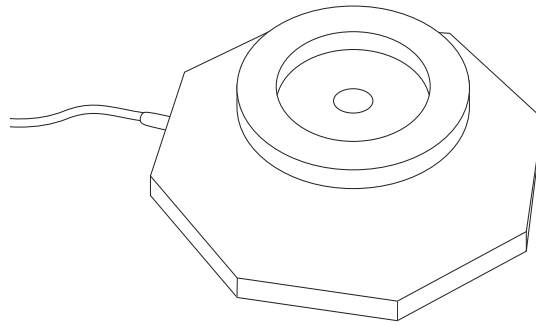

71 mm floating height (max)
 heavy weight  (max 4 kg)

